

NPE - Industrial Computer with GSM/GPRS modem

Monitoring and Steering in one device



- NPE series devices are innovative and effective platforms for modern automated systems and remote monitoring.
- Thanks to the Linux system, they are characterized by stability, functionality, and safety of the highest level.
- NPE drivers are already operating in automated installations in many countries of the world.

Main features

Controller for steering and monitoring systems

- serial port converter
- MODBUS Master/Slave/Gateway
- datalogger, SQL server
- SNMP/MAIL/FTP/WWW server



Satisfies the requirements for devices of scattered systems

- low power consumption
- no-fan housing
- installation on a DIN bus
- Watchdog, SecurityChip, RealTime Clock



A variety of functions and network resources

- Ethernet and a GPRS/EDGE modem
- GPRS router, NAT
- operates with VPN, SSH, PPP protocols and many others
- safety - firewall, SSL



Expanded Developer's Platform

- built-in Linux system
- specially prepared SDK
- rich assortment of programming tools
- services C, C++, JAVA languages



Interfaces and hardware resources

Communicational interfaces

NPE is a universal controller

It was built with the needs of the automation and telecommunication markets, and built-in systems in mind. Shown here are the input/output interfaces making the exchange of information possible, that the computer has at its disposal.

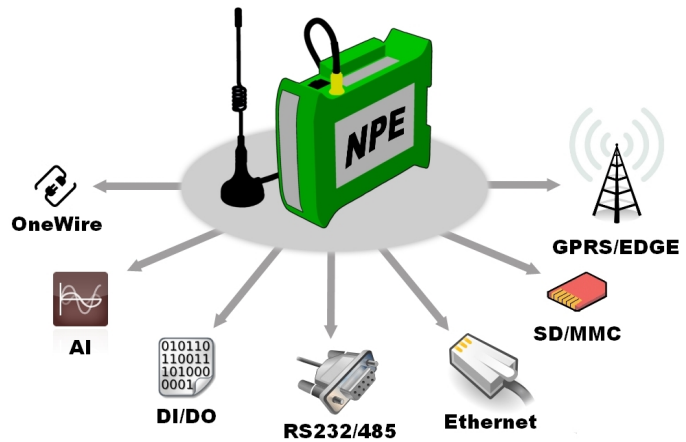

Hardware resources

NPE Architecture

The heart of the computer is an efficient and energy-saving RISC-type ARM9 processor, which, in addition to large memory resources and the Linux system, gives unlimited potential applications.

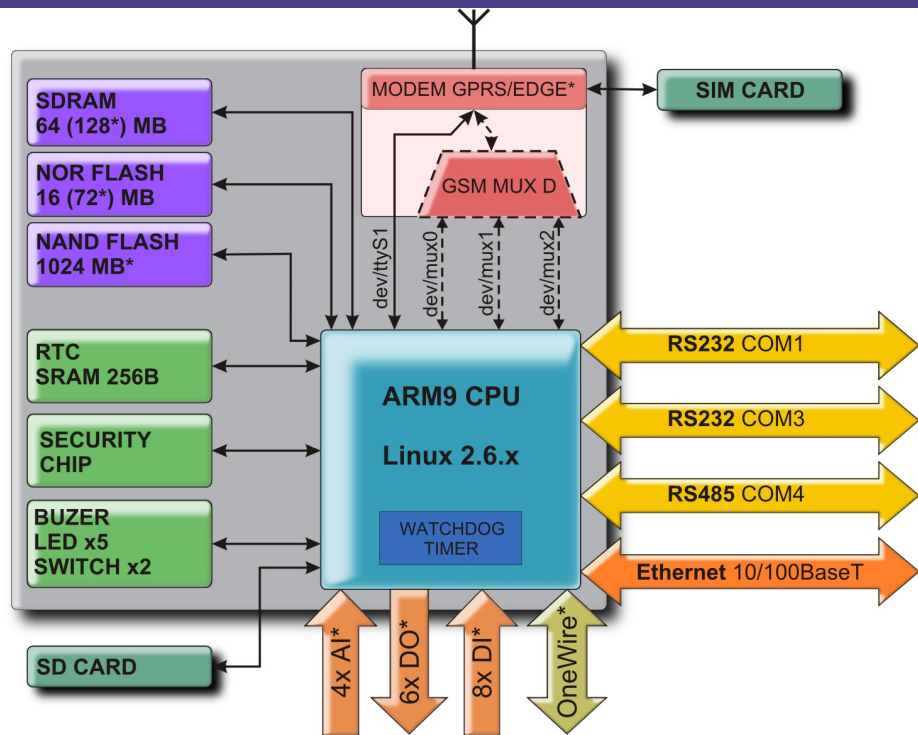

NPE Computer Inner Architecture

Built-in functionality

NPE can work in various modes depending on its configuration. In this way, selected functions can be activated based on the needs to be met.

NPE computer work modes:

- Serial port converter
- Modbus Master/Slave/Gateway
- SNMP server
- Network GPRS router
- Internet server: www/ftp/mail
- Datalogger, SQL server



Serial port converter

In automated systems, communication based on the serial port is still popular. This is why NPE has as many as three ports supporting this solution.

Unlike other devices of similar functionality NPE offers:

- an additional channel of wireless communication GPRS/EDGE
- a virtual serial port for Windows and Linux systems
- non-conflicting connections with up to three appliances connected by serial ports

Example configurations of the serial port converter applications:

- Access to the converter with a public address

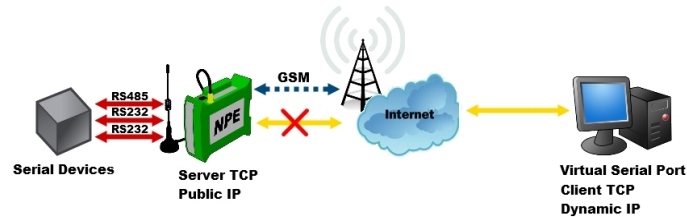

Communication with converter - NPE converter as a server with public IP

- Access to the converter without a public address (with emergency GPRS utilization)

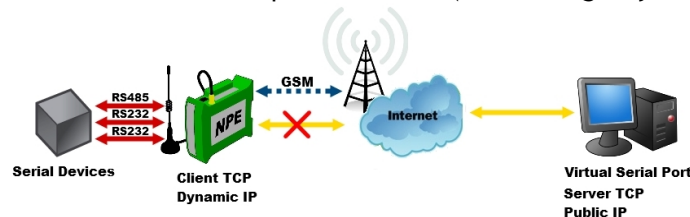

Communication with converter using backup type transmission channel

- Communication without the installation of a virtual serial port

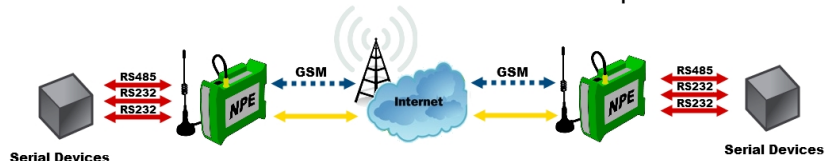

m2m communication - serial transmission through the Internet

MODBUS Master/Slave/Gateway

Modbus is an open standard of communication, widely used in automation. Because of the uncountable number of devices and software using it, the protocol is used very frequently as a medium integrating various systems. NPE can operate in Master and Slave mode for the Modbus protocol.

Modbus Gateway - because of the large amount of slave type devices, the functionality of a Modbus gateway or Modbus proxy is used, thanks to which it is possible to convert the transmission channel from RS-485 buses to TCP/IP, for example.

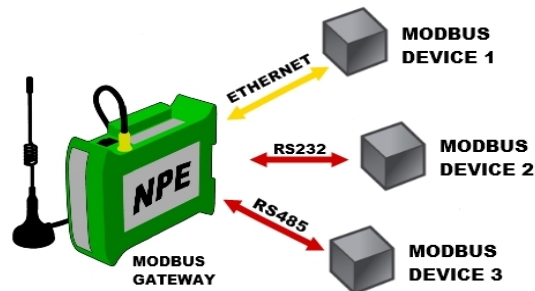

NPE as a device operating in Modbus Gateway mode

Modbus Slave - below, NPE is shown during operation in Modbus Slave mode

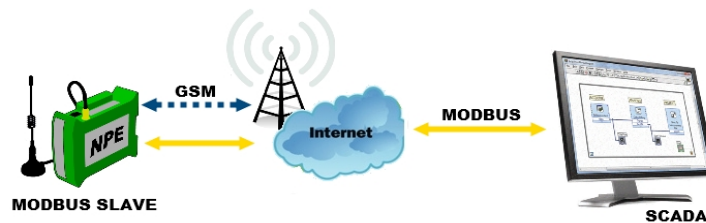

NPE as a device of the Modbus Slave type on a TCP port, communication with SCADA type software

SNMP serwer

SNMP is a popular protocol used for monitoring and steering devices in automation and telecommunications. It has especially found appliances in servicing network devices such as switches and routers.

NPE has an implemented SNMP service thanks to which it can be connected to a uniform system managing devices based on this protocol.

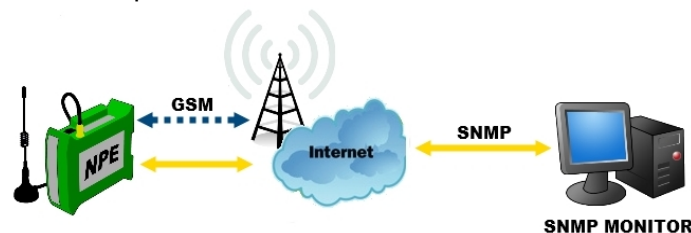

NPE in the function of an SNMP agent

Network GPRS Router

GPRS/EDGE Communication, has found widespread applications in industry as well as subjects of public utility. It is applied in systems such as: energy networks, gas networks, running water networks, weather stations, managing traffic, POS, and construction of LAN VPN networks.

The **NPE computer**, using the **GPRS network**, finds a use in all of the systems mentioned above, speeding up and facilitating the exchange of data.

Below are examples of the **NPE computer's** usage with the utilization of the **GPRS network**:

By combining the LAN and cellular networks (WAN), you can share a GPRS/EDGE connection to the LAN network thanks to built-in NAT technology (Network Address Translation).

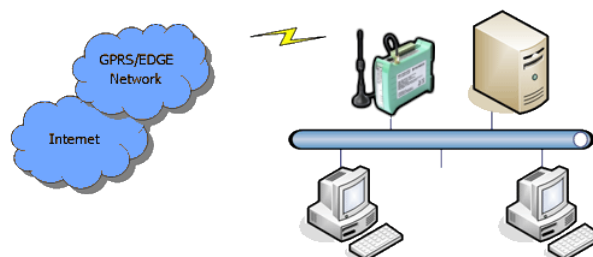

NPE can be connected to terminals that do not service the IP protocol through the RS232/485 interface. After such a connection, the terminal without IP protocol becomes a standard TCP/IP 10/100BaseT network interface.

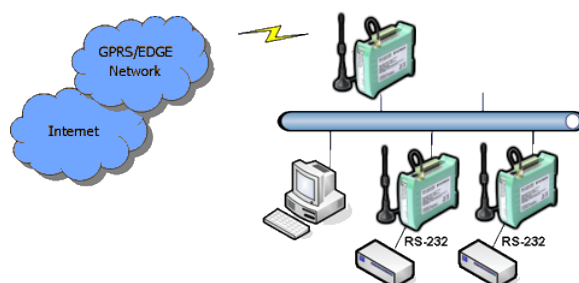

Internet Server

The NPE computer can operate as a fully functional internet server based on software of international quality:

- www server - Apache, Jetty
- PHP script service
- SQL database server - SQL Lite, PostgreSQL
- FTP, mail, telnet with SSH server



Datalogger

NPE services SD cards up to 2GB of capacity and has a built-in fast flash memory of up to 1GB capacity which makes this device a functional data logger. Data can be stored in an SQL database (SQL Lite, PostgreSQL) as well as in files of any structure. Access to the data can take place at any moment by:

- FTP client
- database client
- www page

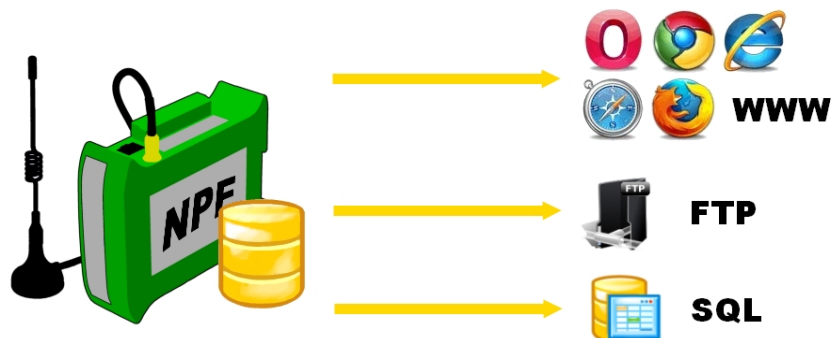

Applications

NPE steering and monitoring systems find applications in the following branches of industry:

- safeguarding and protection
- automation and telecommunication
- power management
- water supply network management
- home/office automation

Below we present a few examples of applications:

Safeguarding and protection - Monitoring UPS feeders in informational systems

In times when the amount of stored data, its significance, and above all, its value, increase rapidly, its protection is crucial. An absence of electricity in the power supply network is very dangerous to electronic devices. In order to protect against such an eventuality, the UPS system is used (Uninterrupted Power Supply). However, they are not unfailing. In order to ensure the stability of the functioning of feed supporting systems in a modern and effective way, we offer the Monitoring of UPS feeders in informational systems. It utilizes NPE 9201-EDGE computers. This is an affordable, failure-free, cutting edge and, above all, effective solution.

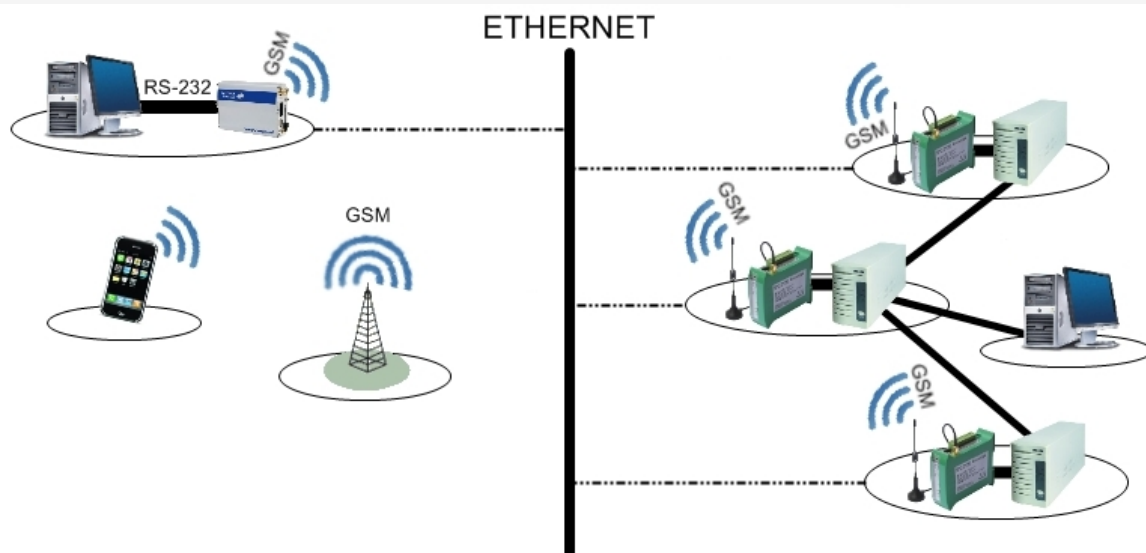

[Learn more about this application](#)



[Download .pdf file concerning this application](#)

Automation and telecommunication - Monitoring and controlling transformers

The rising need for electricity and client demands from suppliers make the matter of supervising their efficient, effective, and stable functioning a priority. Because transformers are found at large distances from each other, using wired technology is expensive and unpractical. An example of effective and wireless supervision based on the newest technology is the monitoring and control system for transformers utilizing the NPE 9201-GPRS industrial computer.



- [→ Learn more about this application](#)
- [Download .pdf file concerning this application](#)

Power engineering Systems controlling the flow of heat energy

Where there is a need to monitor heat flow, there is a need for higher precision. Because of the progressively growing client expectations, solutions based entirely on wired technology are insufficient, devices and installations are often scattered over a large area, and using cable transmissions is unpractical and fallible. The solution to this problem can be a system steering the flow of heat energy controlled by the NPE 9201-GPRS industrial computer.

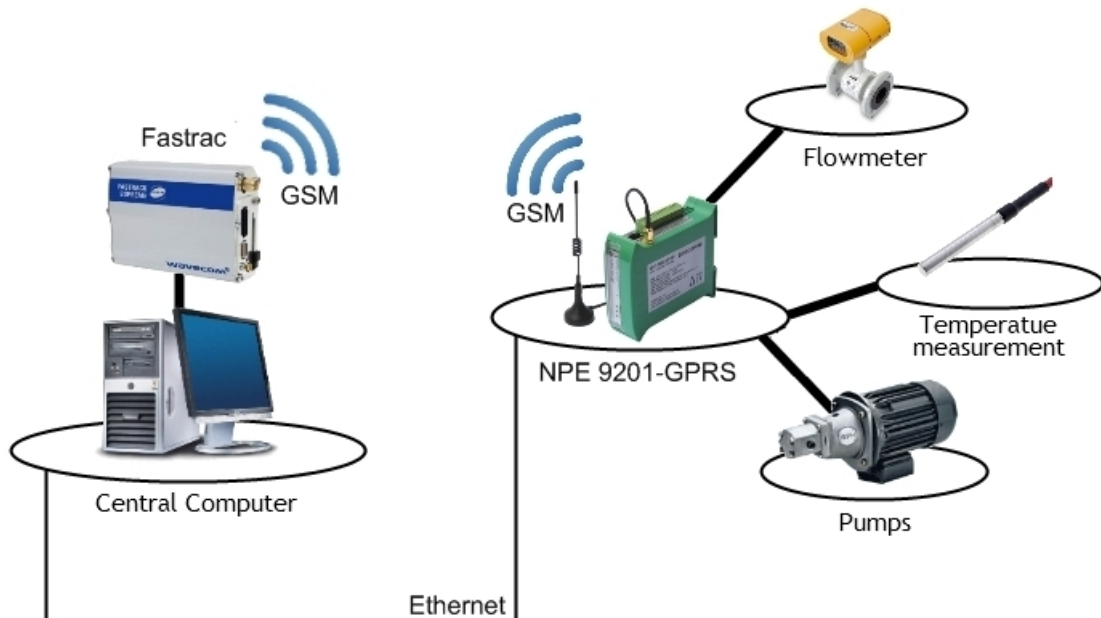

- [→ Learn more about this application](#)
- [Download .pdf file concerning this application](#)

Water management Monitoring water supply networks

Water supply networks are systems of a very specific construction. They are placed over large areas, however, the key installations are concentrated. The selection of an appropriate monitoring system is a hard task requiring the utilization of both wired and wireless technologies. To meet these demanding requirements, a system for monitoring water supply networks using the NPE 9201-GPRS could be essential.

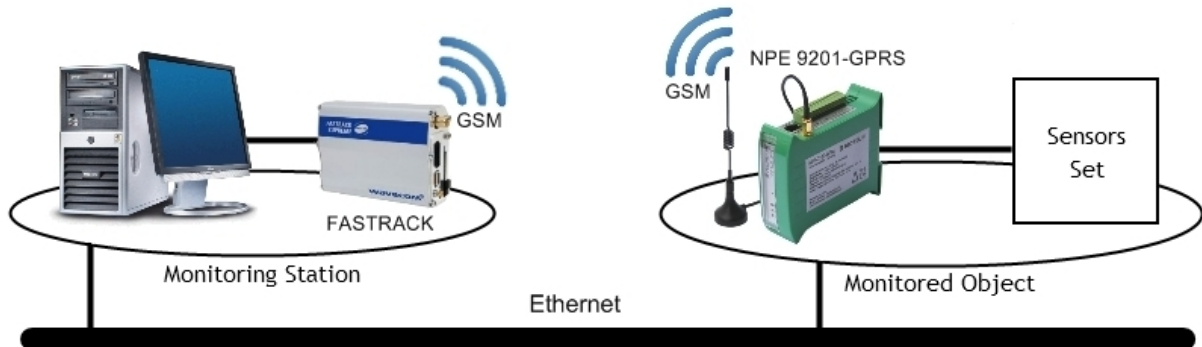

[Learn more about this application](#)

[Download .pdf file concerning this application](#)

Home/Office Automation - Monitoring air conditioning in a room with a server

The modern server is no longer just an ordinary computer, but a warehouse of data, and all measures must be taken to protect this data. Maintaining the appropriate and defined work parameters, such as temperature and humidity, is a very important matter. With the creation and maintenance of optimal conditions for data storage and processing in mind, an air conditioning monitoring system in server rooms was created. It uses NPE 9201-EDGE computers.

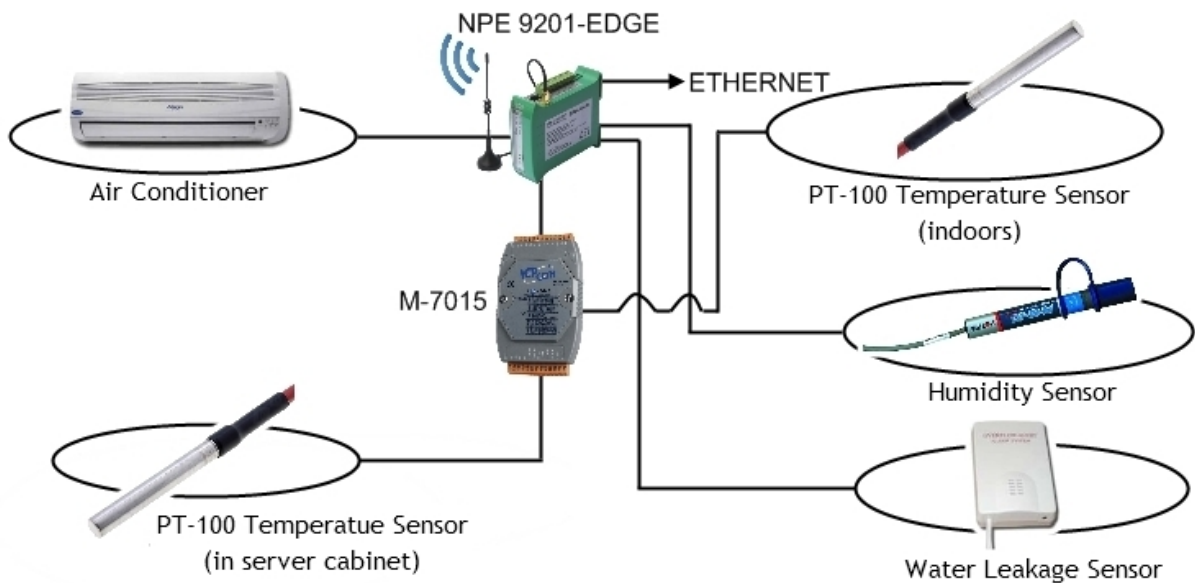

[Learn more about this application](#)

[Download .pdf file concerning this application](#)

Developer's Platform

Why Linux?

Every IT specialist knows what Linux has to offer for servers. More and more often, thanks to the power of energy-saving processors, this system becomes the ideal platform for embedded systems and all kinds of drivers

The Linux system is distinguished by:

- world standards, stability, and unlimited capabilities of platform development
- enormous program and tool bases available free of charge, along with source code
- access to a whole knowledge base, documentation, guides at various levels of proficiency, hundreds of thousands of specialists worldwide

Application Base

NPE operates while using the Linux system, therefore it has access to an enormous application base. Some of them are already precompiled and supplied to the client along with the device.

Selected application examples:

- www server: apache, jetty
- databases: sqlLite, postgreSql
- Programming languages: C/C++, Java, Php
- Services: telnet, ftp, ssh and many others



Linux



WWW



PSQL



SDK



Tools



Java

Apart from the solutions already available, the application base dedicated to NPE is constantly expanding, for example: text message server / gate, serial port converter, SNMP server, modbus. If you want to learn about the current list of available applications, please contact us.

Tools and NPE SDK

Also supplied with the NPE are: documentation, libraries and tools allowing the usage of built-in NPE resources such as: the GSM modem or the digital and analog input/output.

Dedicated products

Dedicated products platform

Due to the enormous amount of tools and applications that are given access to by the Linux environment, NPE series products can serve as an ideal hardware platform for dedicated solutions.

OEM Products

To create your own product, the TechBase Company will supply the NPE base product as an OEM product. In this fashion, the finished product can be distributed under any brand name.

The TechBase Company is developing two authored product series based on NPE. Below, we briefly describe their function:

The iMod series – A Modbus Internet Communication Module

iMod is a configurable Modbus device with the capability of adding service for additional protocols into one system.

The main functions of iMod are:

- downloading data from NPE interfaces or outside devices using the Modbus, mBus, or other protocols
- buffering the gathered data with the option of its archiving
- giving monitoring systems (i.e. SCADA type) or other iMod or PLC drivers access to the data

To learn more about the capabilities of the iMod platform, click here or contact us.

TRM Series - Heating System Telemetry

The TRM series are products based on the NPE platform and designed for **monitoring heat centers**. They have the functionality of telemetric modules cooperating with specific types of regulators and meters. The types of devices with which the TRM module can cooperate with is constantly expanding. Below is an example of a TRM telemetric module communications diagram in relation to regulators of the Danfoss Company.

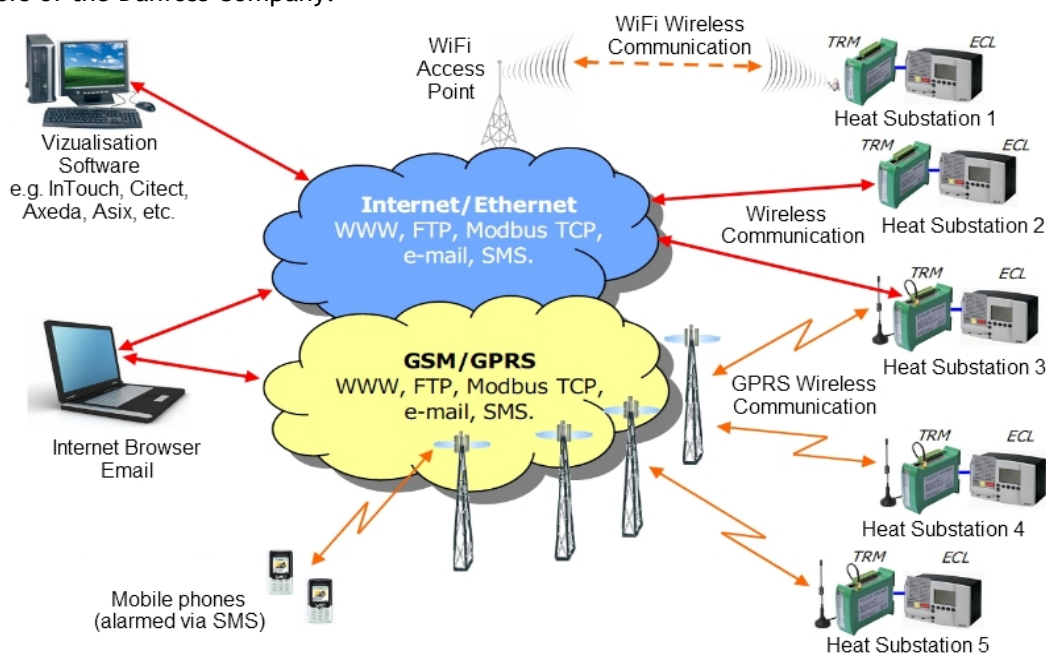

Monitoring and steering of the system takes place with the aid of a built-in www server.

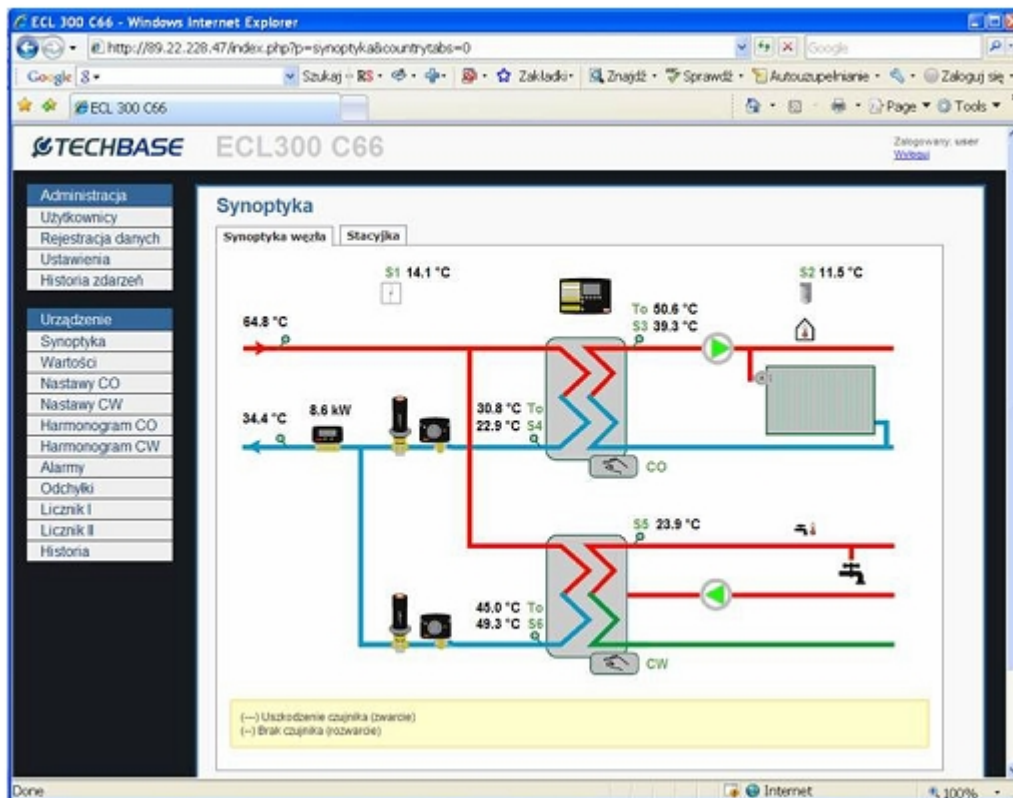

Technical data

Selection Guide

Basic NPE resources - the table shown below presents the base hardware configuration for all NPE series devices

NPE SERIES 9XXX BASE CONFIGURATION								
MODEL	SDRAM	FLASH MEMORY	SD CARD FLASH	RTC	Ethernet	RS-232	RS-485	Digital Inputs
NPE-9XXX	64/128 MB	up to 1 GB	up to 2 GB	●	●	2	1	8

Comparison of NPE models - the table shown below presents the available configuration of NPE series models

NPE - SELECTION GUIDE									
MODEL	DO	DOP	AI DC	AI AC	ONE WIRE	Add. 1 GB Flash	MODEM	MODBUS	SNMP
NPE-9100	6						GPRS/EDGE	○	○
NPE-9100R	2	2					GPRS/EDGE	○	○
NPE-9200	6		4				GPRS/EDGE	○	○
NPE-9201	6		3	1			GPRS/EDGE	○	○
NPE-9200R	2	2	4				GPRS/EDGE	○	○
NPE-9300	6					●	GPRS/EDGE	○	○
NPE-9300W	6				●	●	GPRS/EDGE	○	○
NPE-9300R	2	2				●	GPRS/EDGE	○	○
NPE-9300RW	2	2			●	●	GPRS/EDGE	○	○
NPE-9400	6		4			●	GPRS/EDGE	○	○
NPE-9401	6		3	1		●	GPRS/EDGE	○	○
NPE-9400R	2	2	4			●	GPRS/EDGE	○	○
NPE-9400RW	2	2	4		●	●	GPRS/EDGE	○	○

○ Optional Functionality

● Built-in Functionality

RTC Real Time Clock

DI Digital Outputs

DO Digital Outputs

DOP Digital Output Relay

AI DC Analog Inputs 0...10VDC

AI AC Analog Inputs 0...70VAC

Specifications

System	
CPU	ARM9 32-bit RISC CPU
CPU Frequency	180MHz
CPU MIPS	200MIPS
RAM MEMORY	SDRAM 64 / 128MB*
FLASH MEMORY	16MB / 72MB*
NAND FLASH MEMORY	1GB*
Flash SD	1x socket SD card
System	Linux v 2.6.x
Real Time Clock	RTC, SRAM 240B, Watch Dog Timer
Ethernet Interface	
	Ethernet 10/100Mbps (1x RJ45)
Serial Ports	
RS-232 Ports	2x RS-232, built-in 15KV ESD safety mechanism
RS-485 Ports	1x RS-485, built-in 15KV ESD safety mechanism
	Data bits: 5, 6, 7, 8
	Stop bits: 1, 1.5, 2
	Parity : None, Even, Odd, Space, Mark
	Baud rate: 50 bps to 921.6 Kbps
LED/keyboard/input-output control lamps	
LED signalization	System readiness x 1, user's x 1
Ethernet signalization	LED link, LED 100 Mbit (integrated with the RJ45 socket)
Switch	1 x monostable Switch (front panel access)
Program socket	1 x 6 pin connection (front panel access)
GPIO	8 digital inputs, 2-6 digital outputs, Optionally: 4 analog inputs, 2 relay outputs
Power supply	
Supply voltage	12 - 36 Vdc (optionally 12 - 48 Vdc - telecommunications range)
Power consumption	7W max
Mechanical Parameters	
Dimensions	(width x depth x height) 35 x 120 x 101 mm
Weight	10.58 oz
Housing	ABS, DIN bus installation
Operating and storage conditions	
Work parameters	Working temperature: -10 to 60° C Humidity: 5 - 95%RH (without condensation) Optionally: -40 to 75° C (for NPE-9100-E)
Storage Parameters	Storage temperature: -20 to 80° C Humidity: 5 - 95%RH (without condensation) Optionally: -40 to 85° C (for NPE-9100-E)

* - options available in the NPE-9300/9400 Series models with additional fee

About document

The current document is meant to present the capabilities of an NPE series industrial computer in a general fashion. Specific information about the product is available in other documents on our internet site www.a2s.pl.

If you have any question, please send us an e-mail to the address given info@a2s.pl or contact us by phone at **(58) 345 39 22** during our company's working hours.

The manufacturer and designer of NPE series computers is the **TechBase Sp z o.o.** Company. We also reserve the right to modify the parameters shown in the current document without notice.

Contents

NPE - Industrial Computer with GSM/GPRS modem	1
Main features	1
Interfaces and hardware resources	2
Built-in functionality	3
Serial port converter	3
MODBUS Master/Slave/Gateway	4
SNMP server	4
Network GPRS Router	5
Internet Server	6
Datalogger	6
Applications	7
Developer's Platform	10
Why Linux?	10
Application Base	10
Tools and NPE SDK	10
Dedicated products	11
The iMod series – A Modbus Internet Communication Module	11
TRM Series - Heating System Telemetry	11
Technical data	13
Selection Guide	13
Specifications	14
About document	15
Contents	15